

LIGO detects gravitational waves

The twin laser interferometers nearly simultaneously received the call of two black holes in the violent final instants of their merger.

On 11 February of this year, David Reitze, executive director of the Laser Interferometer Gravitational-Wave Observatory (LIGO) Laboratory stood before a crowd of reporters at the National Press Club in Washington, DC, and declared, “Ladies and gentlemen, we have detected gravitational waves. We did it!” That announcement was the crowning moment in a story that spans more than four decades.

The story opens as the 1960s are winding down. Rainer Weiss, then a young physics professor at MIT, was teaching a course in general relativity. As a classroom exercise, he gave his students a simple thought experiment: Imagine three test masses at the vertices of a right triangle—how would gravitational waves affect light beams that travel along the triangle’s perpendicular sides? A spacetime-distorting gravitational wave would produce a phase difference between the beams.

Realizing that advances in lasers could turn his thought experiment into a real one, Weiss wrote up in 1972, in an internal MIT report, his idea for a kilometer-scale interferometer and a list of all the possible noise sources he could think of. By 1983 he had teamed up with Ronald Drever and Kip Thorne, both at Caltech, to propose the pair of interferometers that ultimately became LIGO. NSF approved construction of LIGO in 1990, and it took nearly another decade to build the two 4 km instruments, one in Livingston, Louisiana, and the other in Hanford, Washington. (The original Hanford instrument had a second 2 km interferometer.)

Along the way, the three-person team of Weiss, Thorne, and Drever evolved into LIGO Laboratory, the joint Caltech-MIT venture that operates the LIGO instruments. In 1997, Barry Barish, the second executive director of LIGO Laboratory, established the LIGO Scientific Collaboration, which today includes more than 1000 scientists from 83 institutions worldwide.

An alternate telling might start 1.3 bil-

lion years ago in a far-off region of space roughly in the direction of the Large Magellanic Cloud. A 29 solar-mass (M_{\odot}) black hole merged with a 36 M_{\odot} black hole to form a single 62 M_{\odot} black hole. The violent union radiated away 3 $M_{\odot}c^2$ worth of energy as gravitational waves.

The waves reached the Livingston detector on 14 September 2015 at 5:51am local time; 7 ms later, they reached the Hanford detector.¹ Labeled GW150914, the 0.2-second-long event, shown in figure 1, confirmed in spectacular fashion Albert Einstein’s prediction that gravitational waves exist.

The interferometers

Because gravitational waves, most often described as ripples in spacetime, are oscillations in the spacetime *tensor* (technically, a tensor of rank 2), they differ in important ways from more familiar electromagnetic waves. In particular, they are quadrupolar: As a gravitational wave moves through space, one transverse direction stretches while the other compresses.

With arms 4 km long, the two LIGO detectors are the world’s largest and most sensitive Michelson interferometers. A passing gravitational wave changes the relative lengths of the two arms in each instrument and thus the interference condition of the light beams when they recombine. (For more on interferometric measurements of gravitational waves, see the article by Barry Barish and Rainer Weiss, *PHYSICS TODAY*, October 1999, page 44.)

The observed strain, a mere 10^{-21} , implies that the length changes in LIGO’s arms were 1/1000 the radius of an atomic nucleus. At face value, that’s an impossibly small value to measure. LIGO’s solution is to turn each arm into a resonant

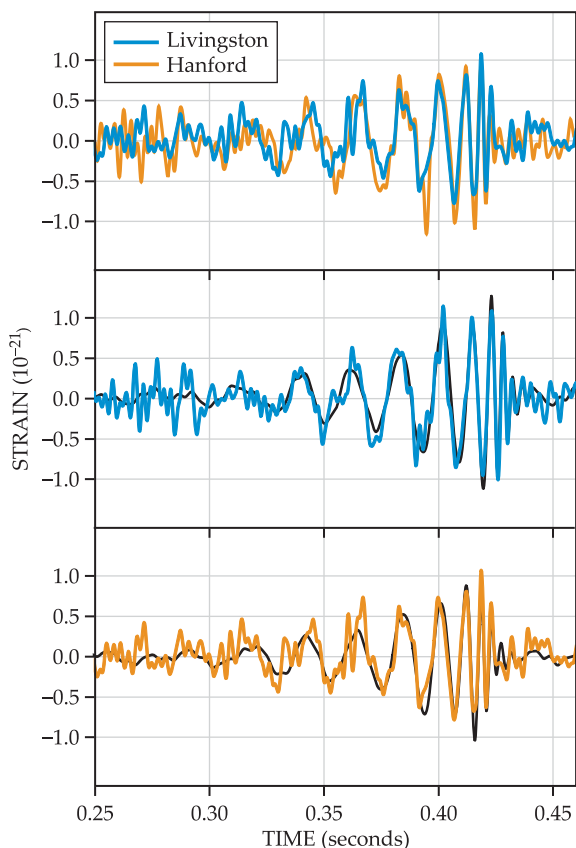

FIGURE 1. SIGNALS RECEIVED by the Laser Interferometer Gravitational-Wave Observatory instruments in Livingston, Louisiana, and in Hanford, Washington, were the first direct detection of gravitational waves. At top, the Hanford signal has been shifted in time to correct for the arrival-time delay between the two detectors, and inverted to account for the Hanford detector’s orientation relative to Livingston. The lower two panels show the observed data individually, along with best-fit calculations (black) generated from numerical relativity simulations. (Courtesy of Caltech/MIT/LIGO Laboratory.)

optical cavity (see figure 2). Light injected into the cavities bounces back and forth hundreds of times before recombining. In effect, the cavity increases the light’s path length from 4 km to more than 1000 km. The attometer-size length change in the arms thus becomes a more manageable, although still impressive, femtometer-size difference in the light’s path length.

In the end, though, the name of the game is signal to noise. At the high-

frequency range of LIGO's detection band (10 Hz to 7000 Hz), the dominant source of noise is quantum fluctuations in the detected photon arrival rate. Because LIGO is configured for near-complete destructive interference at the photodetector, almost all the light ends up reflected back toward the laser source. LIGO incorporates mirrors that recycle that light back into the system. Together with the optical cavity, the scheme boosted the 20 W input laser power to 100 kW in the interferometer arms.

At lower frequencies (below 150 Hz) seismic, thermal, and radiation-pressure noise come into play. Eliminating as much of that noise as possible was crucial to LIGO's success. Between 2010 and 2014, the instruments underwent a complete overhaul to become Advanced LIGO. (See *PHYSICS TODAY*, September 2015, page 20.) Improvements included the installation of an active seismic isolation system and the replacement of the 11 kg mirrors in the optical cavities with 40 kg mirrors for reduced thermal noise and radiation-pressure noise. In addition, the mirrors were hung from a quadruple pendulum system (see figure 3) to better dampen any mechanical vibrations that might get past the active system.²

When LIGO detected GW150914, it was running in low-power mode. By 2019, when the upgraded instruments are fully commissioned and operating at full power, Advanced LIGO should have a sensitivity 10 times that of the initial LIGO detectors.

The signal

That both LIGO detectors saw GW150914 is important evidence that the event was astrophysical. The behavior of the observed waves—the steady increase in frequency from 35 Hz to 250 Hz, at which the signal amplitude reaches a maximum, followed by an amplitude decay at constant frequency—suggests two compact massive objects spiraling in toward each other and merging.

Estimates based on the signal's frequency and its time derivative showed that the total mass of the binary system was too large for both objects to be neutron stars. A black hole–neutron star pair could have enough mass but its gravitational waves would come at a lower frequency. Eliminating those two possibilities left a black hole binary as the only plausible source.

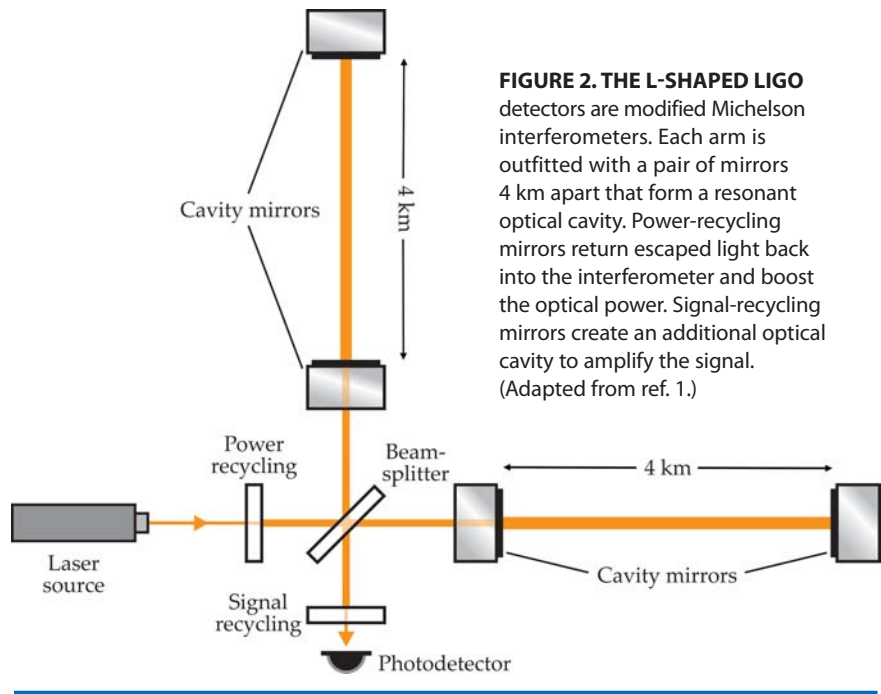

FIGURE 2. THE L-SHAPED LIGO detectors are modified Michelson interferometers. Each arm is outfitted with a pair of mirrors 4 km apart that form a resonant optical cavity. Power-recycling mirrors return escaped light back into the interferometer and boost the optical power. Signal-recycling mirrors create an additional optical cavity to amplify the signal. (Adapted from ref. 1.)

In the months following detection, the LIGO team performed the arduous computational task of comparing the observed time-varying amplitude and frequency with those of different waveforms generated by numerical relativity simulations. From those comparisons, the scientists could determine the masses of the two black holes prior to merger, the mass and spin of the black hole after merger, and the distance from Earth to the black holes.

General relativity

The detection of GW150914 by LIGO was not the first time gravitational waves have been observed or at least inferred. In 1974 Joseph Taylor Jr and Russell Hulse discovered the first binary pulsar, for which they were awarded the 1993 Nobel Prize in Physics (see *PHYSICS TODAY*, December 1993, page 17). Measurements of the pulsar's orbital decay gave convincing quantitative evidence that binary neutron stars lose energy to radiated gravitational waves.

However, GW150914 was the first direct measurement of gravitational waves. Until then, all tests of general relativity have been in the limit of weak gravitational fields. Gravitational-wave observations enable researchers to test general relativity in the limit of strong gravitational fields and rapidly changing space-time curvature.

Advances in numerical relativity have fortuitously come at the right time. Thanks to accurate numerical models,

LIGO scientists could confidently pin down parameters such as the amount of energy radiated away as gravitational waves. "You can only do that if you really solve Einstein's field equations," explains Weiss.

Thus far, general relativity has explained the first binary black hole merger strikingly well. Any disagreement between theoretical models and future experimental results will likely send researchers on a hunt for new physics.

Astrophysics

Observing a binary black hole merger, "may be as important as the fact that we were finally able to detect gravitational waves," says Reitze. The LIGO discovery proves that black hole binaries exist, and that those binaries can merge within the age of the universe.³

The large masses of the black holes involved in GW150914 imply that they were remnants of massive stars that formed in an environment with about half the "metal" (elements heavier than helium) content in the solar system. (See the article by Anna Frebel and Volker Bromm, *PHYSICS TODAY*, April 2012, page 49.) Further, by assuming that GW150914 is representative of binary black hole systems at similar distances to Earth, the LIGO team estimates that the rate of binary black hole mergers is between 2 a year and 400 a year in every cubic gigaparsec (1 parsec = 3.3 light-years) of space.

Two types of astrophysical models predict the kind of merger seen by LIGO.

FAST SDD®
Count Rate >1,000,000 CPS

SDD Spectrum

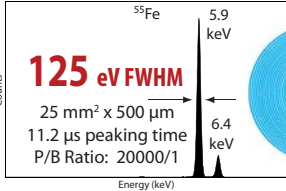

125 eV FWHM
 25 mm² x 500 μm
 11.2 μs peaking time
 P/B Ratio: 20000/1

Resolution vs Peaking Time

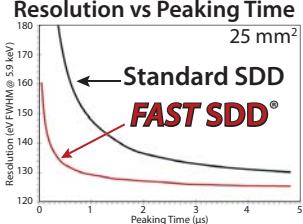

Resolution	Peaking Time
125 eV FWHM	4 μs
130 eV FWHM	1 μs
140 eV FWHM	0.2 μs
160 eV FWHM	0.05 μs

Choose your configuration

OEM Components



Complete Spectrometer



Experimenters Kit



Detector System



OEM's #1 Choice

AMPTek Inc.
 www.amptek.com

AMETEK
 MATERIALS ANALYSIS DIVISION

The first posits the metamorphosis of a massive binary star system into a black hole binary. The second imagines separately formed black holes inside a globular cluster—a dense region of space containing 10^9 to 10^{10} stars—that gravitationally capture each other. More observations by LIGO and other gravitational-wave detectors should provide better constraints for astrophysical models.

Neutron-star binaries or black hole–neutron star pairs are other compact objects that can produce, during a merger, gravitational waves that are strong enough to detect. (See the article by Gijs Nelemans, *PHYSICS TODAY*, July 2006, page 26.) In those cases, tidal forces are expected to distort the shape of the neutron star. Accurate measurements of perturbations in the orbital period caused by those distortions could give researchers a way to probe the stiffness of the nuclear material inside the neutron star.

Other targets of searches include continuous gravitational waves from a rapidly rotating neutron star (pulsar) that wobbles due to a misalignment between its rotation axis and its magnetic field, and the combined gravitational-wave background from the primordial universe. Of course, LIGO scientists also hope to detect previously unknown sources.

Beyond first detection

The source of a gravitational wave can be located by comparing arrival times at different locations. With only two detectors, the LIGO team could narrow the direction from which the gravitational waves arrived to a 0.2-steradian patch in the sky.

Of the other gravitational-wave efforts around the world, an upgraded Virgo detector in Italy is due to come on line later this year and the underground Kamioka Gravitational Wave Detector in Japan is under construction. Both detectors have arms that are 3 km long. With its 600 m arms, GEO600 in Germany is less sensitive and serves as a testbed for new ideas such as the use of so-called squeezed light to reduce quantum noise (see the Quick Study by Sheila Dwyer, *PHYSICS TODAY*, November 2014, page 72, and *PHYSICS TODAY*, November 2011, page 11). Days after LIGO's detection of gravitational waves, the Indian government gave the go-ahead for LIGO India, a project to locate an Advanced LIGO detector in India.

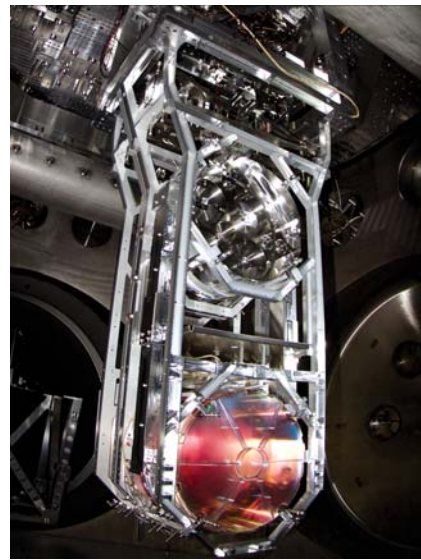

FIGURE 3. EACH MIRROR in LIGO's optical cavities sits at the end of a so-called quadruple pendulum. The 40 kg mirror (bottom) is not attached to the outside frame but hangs from the 40 kg silica cylinder above it by a set of fused silica fibers. The cylinder in turn hangs from a metal mass, which is hanging from yet another suspended metal mass. The system is designed to minimize thermal noise and passively dampen any environmental vibrations that get past LIGO's active seismic isolation system. (Courtesy of Caltech/MIT/LIGO Laboratory.)

As those detectors join LIGO to form a global network, scientists should be able to far better localize gravitational-wave sources. Then the detection of gravitational waves could trigger the use of traditional telescopes to immediately search for electromagnetic counterparts. For example, the coincident detection of gravitational waves with a fast gamma-ray burst could help astrophysicists learn a great deal about the merger of two neutron stars.

The discovery of GW150914 marks the birth of gravitational-wave astronomy. Says Weiss, "We're not done by a long shot." Right now, LIGO scientists expect to see one event per month. But eventually, they hope to get to an event rate on the order of one per day. "We're planning on that," says Weiss.

Sung Chang

References

1. B. P. Abbott et al. (LIGO Scientific Collaboration and Virgo collaboration), *Phys. Rev. Lett.* **116**, 061102 (2016).
2. J. Aasi et al. (LIGO Scientific Collaboration), *Class. Quantum Grav.* **32**, 074001 (2015).
3. B. P. Abbott et al. (LIGO Scientific Collaboration and Virgo collaboration), *Astrophys. J. Lett.* **818**, L22 (2016).